

4

3

2

1

A

B

C

D

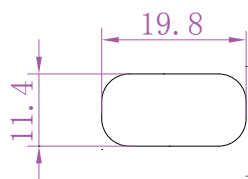
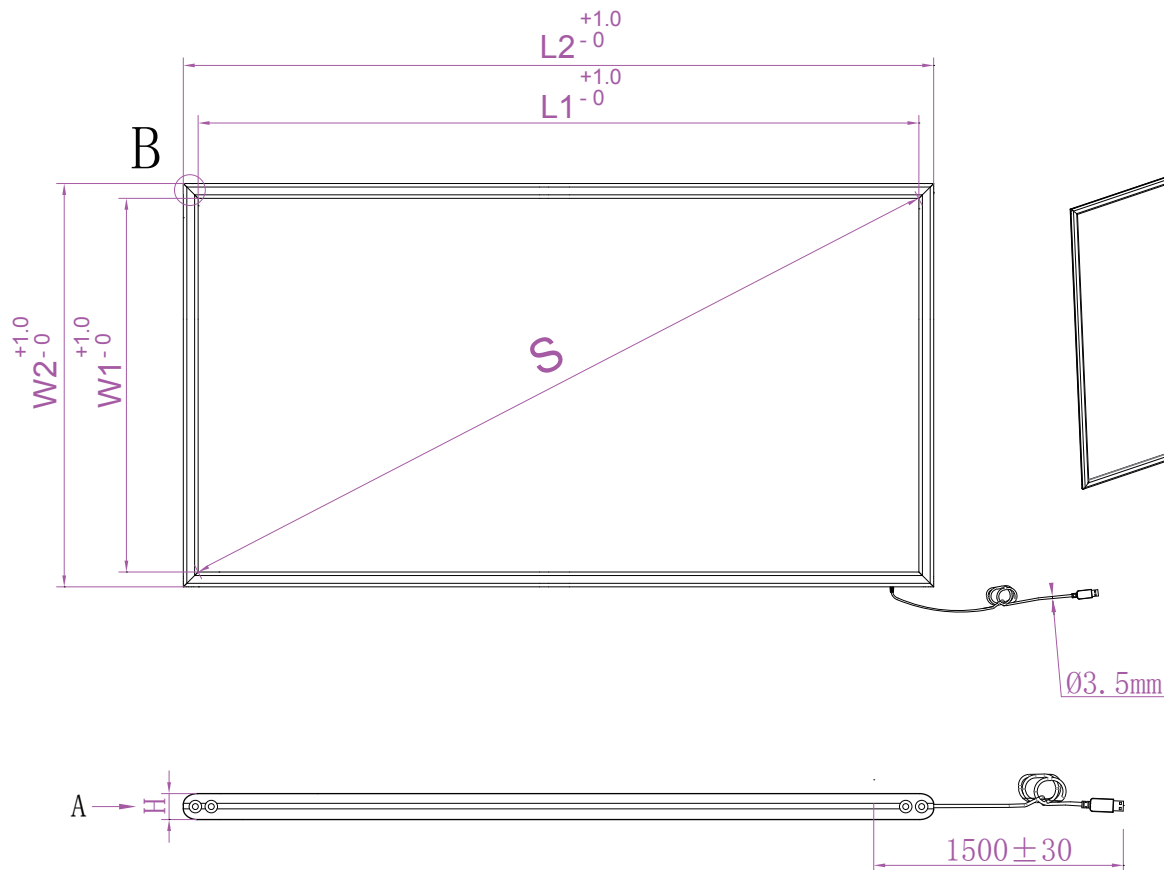
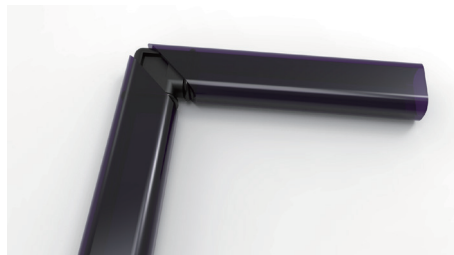

A

S(Inch/mm)	52.76"/1340.24
W1	658.9(+1/-0)
W2	698.5(+1/-0)
L1	1166.3(+1/-0)
L2	1205.9(+1/-0)
H	11.4 ±0.2



Anti-Sunlight, No Blind Zone For Any Size



Material:	plastic	Unit:	mm	Date:		Rev:	1.0
Draft by:		Approved by:					

4

3

2

1