

4

3

2

1

A

B

C

D

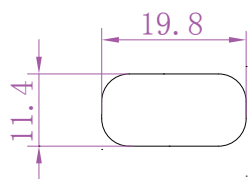
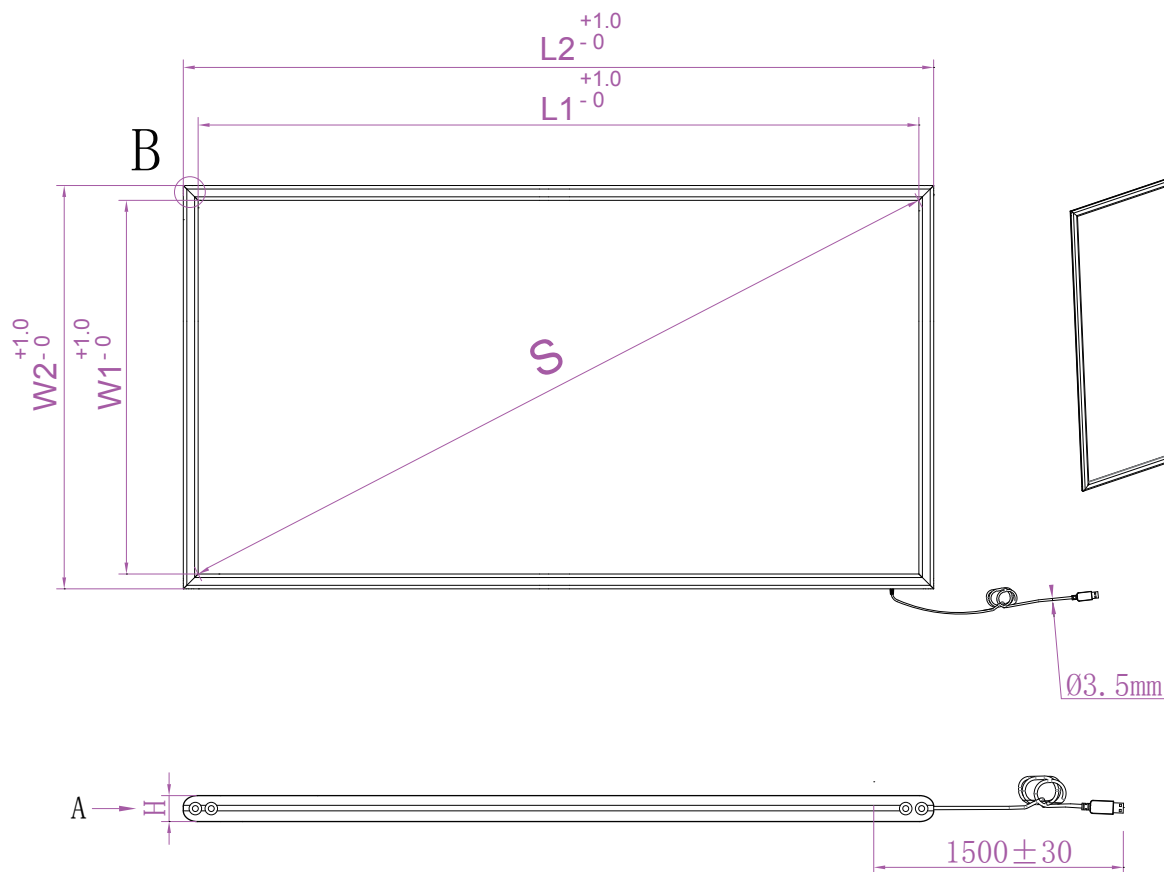
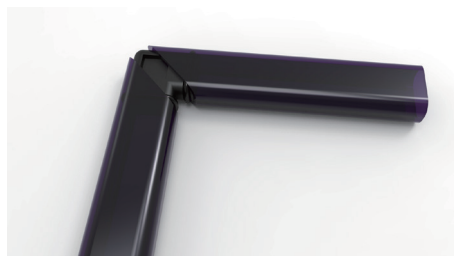

A

S(Inch/mm)	60.77"/1543.68
W1	759.2(+1/-0)
W2	798.8(+1/-0)
L1	1343.3(+1/-0)
L2	1382.9(+1/-0)
H	11.4 ±0.2



Anti-Sunlight, No Blind Zone For Any Size



Material:	plastic	Unit:	mm	Date:		Rev:	1.0
Draft by:		Approved by:					

4

3

2

1