

4

3

2

1

A

B

C

D

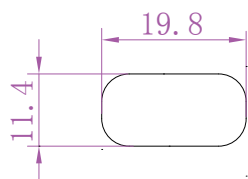
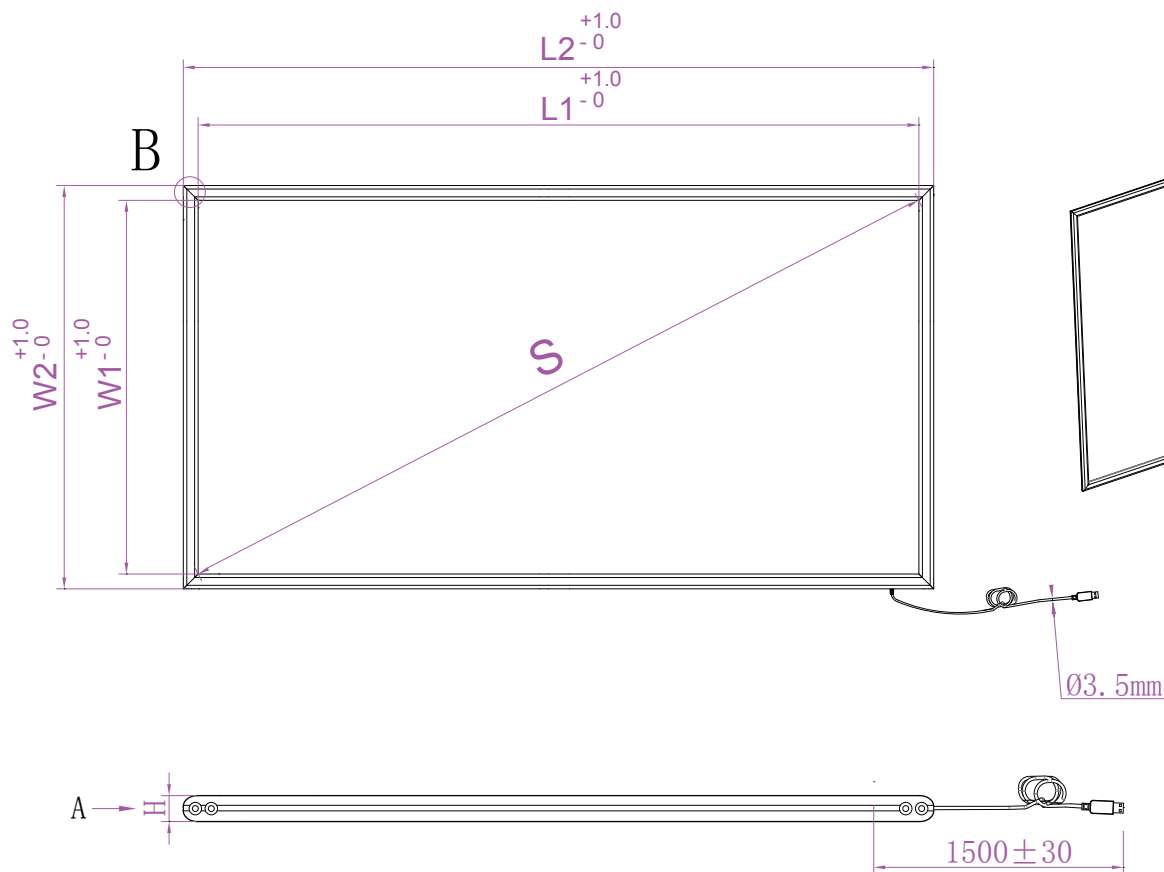
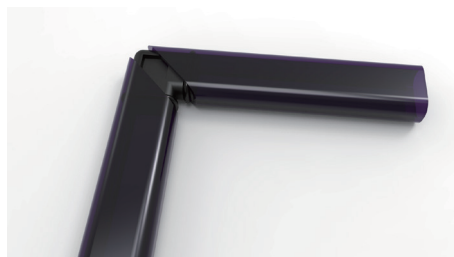

A

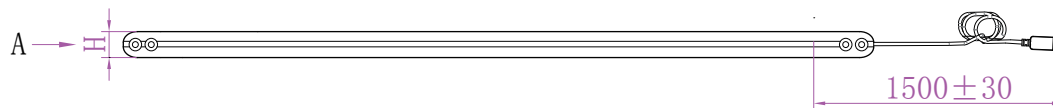

S(Inch/mm)	84.99"/2162.05
W1	1066(+1/-0)
W2	1105.6(+1/-0)
L1	1880.2(+1/-0)
L2	1919.8(+1/-0)
H	11.4 ±0.2



Anti-Sunlight, No Blind Zone For Any Size



Material:	plastic	Unit:	mm	Date:		Rev:	1.0
Draft by:				Approved by:			

4

3

2

1